

Viewport

SEMICONDUCTOR | ANALYTICAL EQUIPMENT | AEROSPACE | TELECOMMUNICATIONS



OIL EXPLORATION | R&D | HIGH ENERGY PHYSICS | MILITARY/DEFENSE | BIOTECHNOLOGY



*Advanced Ceramic-to-Metal &
Glass-Ceramic Sealing Technology*

Description

A viewport, sometimes referred to as a window, is an optical component that provides a means for visual, optical or broad-band energy transmission in and out of a vacuum system.

There are two types of viewports offered, zero-length and tubulated. A zero-length viewport has a thickness no larger than that of its mounting flange. This makes it easier to protect from accidental damage as there are no parts protruding from the mounting flange. It also allows for the best angle of view.

CeramTec's precision-engineered Ceramaseal® viewports are available with a choice of two viewport materials: sapphire or fused silica. Other viewport materials are available upon request.

CeramTec offers a UV grade fused silica viewport with a 1.37" view diameter that can be used for cryogenic applications.

Sapphire should be used in the most demanding applications, as this material provides extended transmission, temperature, pressure and wear resistance.

To select the right window for your applications, you should consider size, transmission requirements, temperature, pressure, and aggressiveness of environment.

Standard Specifications

Sapphire:

- Temperature Range: -269° C to 450° C
- Standard transmission range 0.25 to 4 microns
- Internal Pressure 1×10^{-10} torr to 400 psig
- Viewing diameters from .55" to 1.94"

Fused Silica:

- Temperature Range: -65° C to 200° C
- Standard Transmission Range 0.25 to 2 microns
- Internal Pressure 1×10^{-10} torr to 115 psig
- Viewing diameters from 1.13" to 3.81"

Extended Range:

- Optics: Zinc Selenide, Cleartran, Magnesium Fluoride, Calcium Fluoride
- Temperature Range: -8°C to 204°C

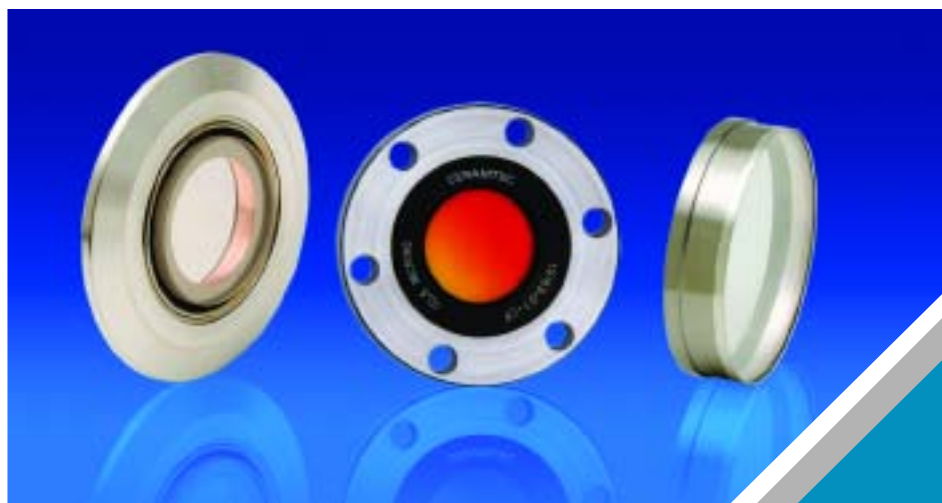

- Standard transmission ranges from 0.12 to 20 microns
- Viewing diameter of .50" or 1.1"
- Anti-reflective (AR) coatings are optional

Extreme / Custom Design

- Double viewports
- Viewing diameters exceeding 7 inches
- Internal pressures to 80,000 psig
- RF applications and special configuration requirements

Installation

Standard installation mountings include:

- Braze (sapphire only)
- Weld (Pulse-TIG, TIG, Laser, E-Beam)
- ConFlat flange
- ISO KF flange

Applications

A few of the many applications in which these viewports are commonly used are:





- Semiconductor processing equipment
- Accelerators
- Furnaces
- Instrumentation
- Analytical test and measurement equipment
- CO₂ lasers
- Multispectral applications
- Optical imaging
- Materials processing
- Thermometry
- Pyrometry

New Products

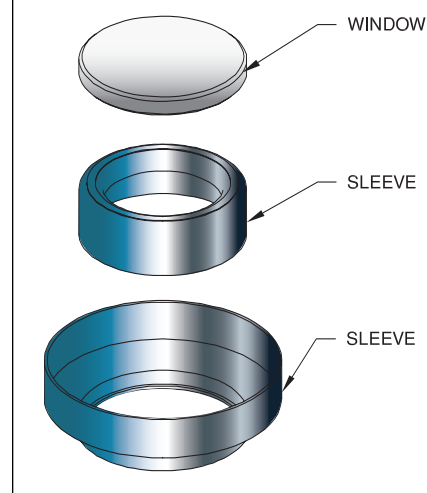
- Extended Range Viewports
- Differentially Pumped Viewports

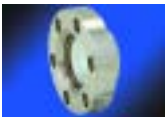
Typical Viewport Construction



Type	View Dia. (inches)	Internal Pressure Rating (@ 20 °C)	Temperature Range	Transmission Range	Sub-section	Section Pages
	0.55 to 1.94	to 400 psig	-269° C to 450° C	0.25 to 4 Microns	Sapphire	F.1 172-173
	1.13 to 3.81	to 115 psig	-269° C to 200° C	0.25 to 2 Microns	Fused Silica	F.2 174-175
	.50 to 1.10	–	-8° C to 204° C	0.12 to 18 Microns	Extended Range	F.3 176-177
	1.10	–	-8° C to 204° C	10.6 Micron Optimized	Differentially Pumped	F.4 178-179

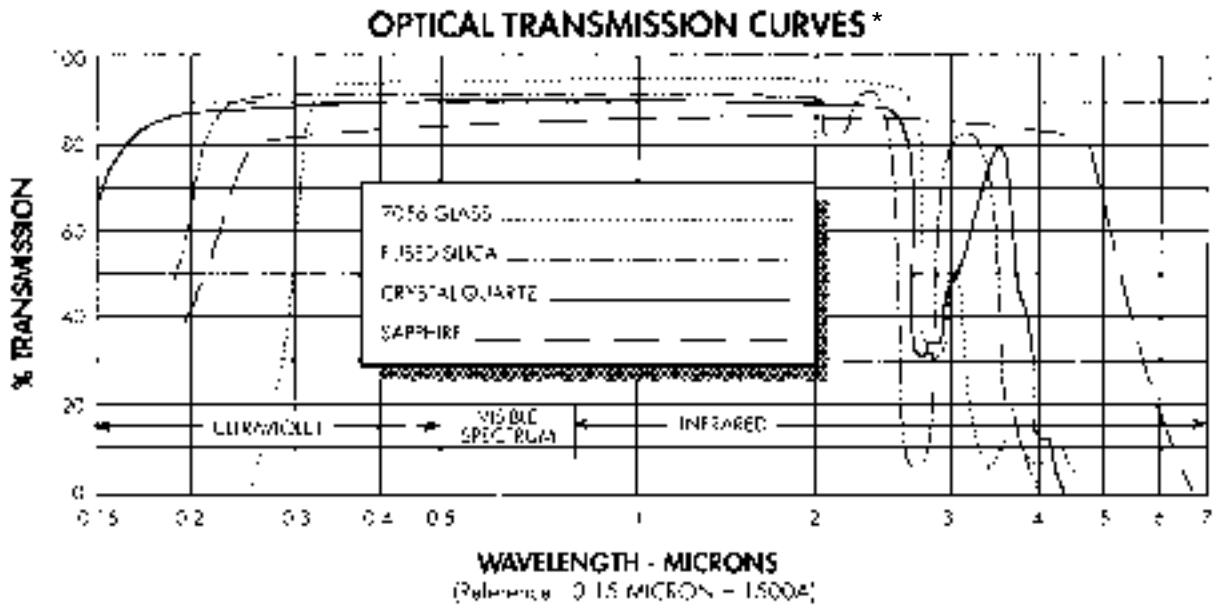

*The 7056 Glass, Fused Silica, and Crystal Quartz transmission curves are based on a thickness of 1 cm. The sapphire transmission curve is based on a thickness of 1 mm.

View Diameter: .55 [14]
Weldable

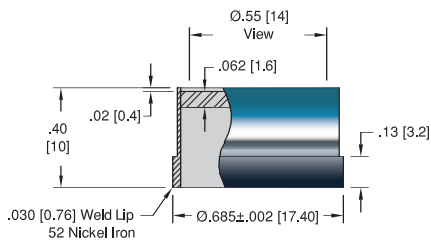

ISO KF

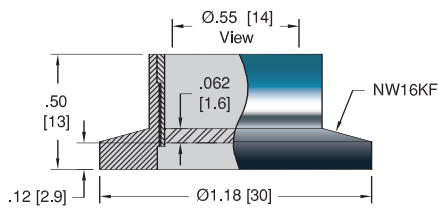

ConFlat

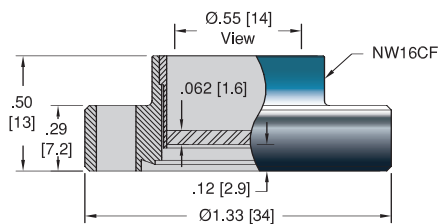

View Diameter: .94 [24]
Weldable

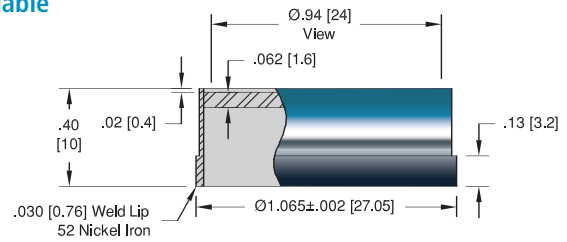

ISO KF

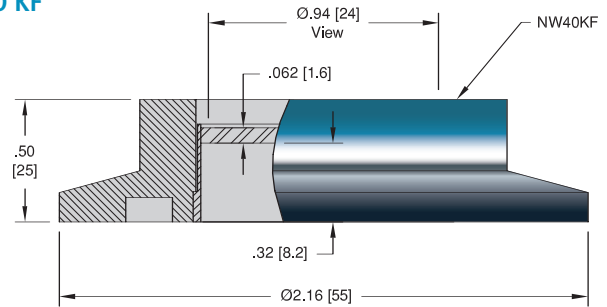

ConFlat

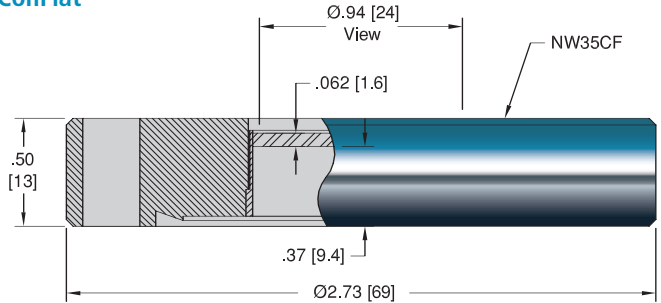

View Diameter: 1.94 [49.3]
Weldable

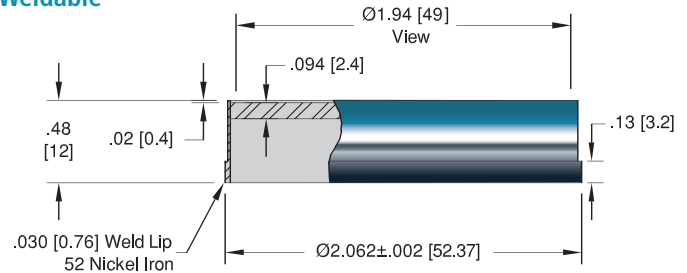

ConFlat

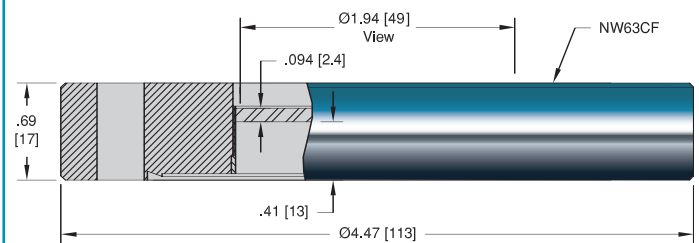

Specifications

Materials

Housing: 52 Nickel iron
Optic: Sapphire
Magnetic Materials: Yes

Transmission Range (80% Min) 0.25 to 4 Microns



Temperature Range -269°C to 450°C, ISO KF -25°C to 205°C

Pressure @ 20°C ISO KF 0 PSIG

.55 View Dia.: 400 PSIG (27.6 Bar)

.94 View Dia.: 160 PSIG (11 Bar)

1.94 View Dia.: 50 PSIG (3.4 Bar)

Weldable	VIEW DIAMETER	INSTALLATION	PART NUMBER
	.55 [14]	Weld	17105-01-W
	.94 [24]	Weld	17105-02-W
	1.94 [49]	Weld	17105-03-W
ISO FLANGE			
	.55 [14]	NW16KF	17106-01-KF
	.94 [24]	NW40KF	17106-02-KF
CONFLAT FLANGE			
	.55 [14]	1 1/3" (NW16CF)	9547-04-CF
	.94 [24]	2 3/4" (NW35CF)	18617-01-CF
	1.94 [49]	4 1/2" (NW63CF)	18617-02-CF



View Diameter: 1.13 [28.7]
Weldable

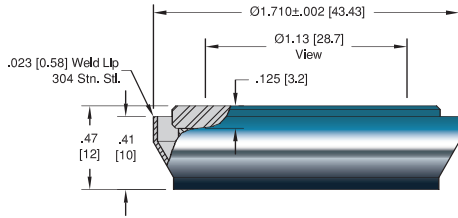

ISO KF

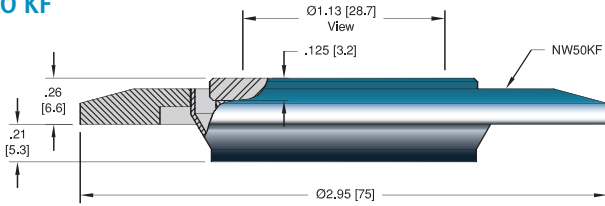

ConFlat

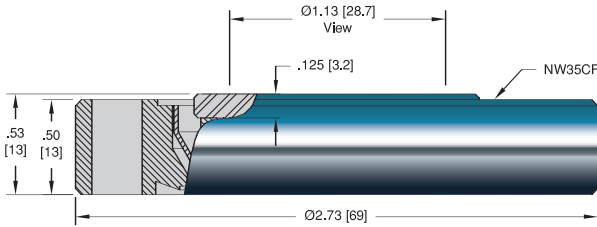

View Diameter: 3.81 [96.8]
Weldable

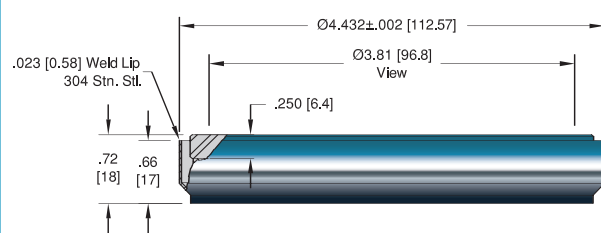

ConFlat

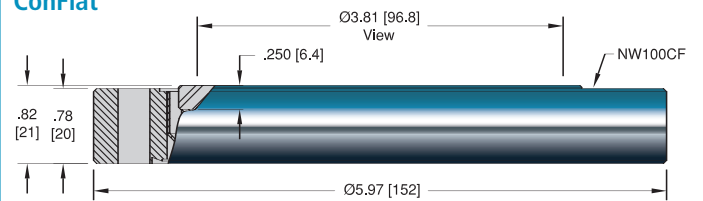

Cryogenic – View Diameter: 1.37 [35]
Weldable

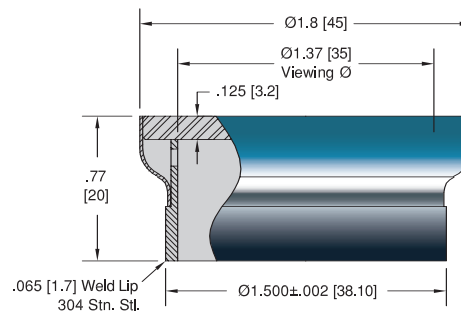

ConFlat

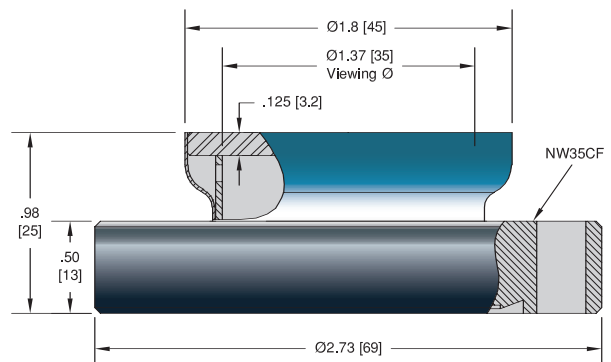

View Diameter: 2.37 [60.2]
Weldable

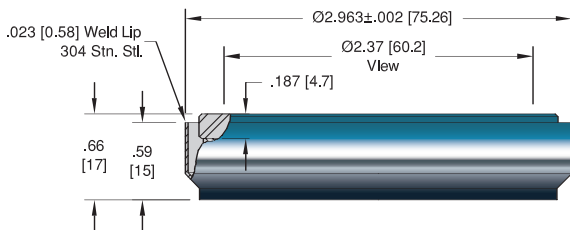

ConFlat

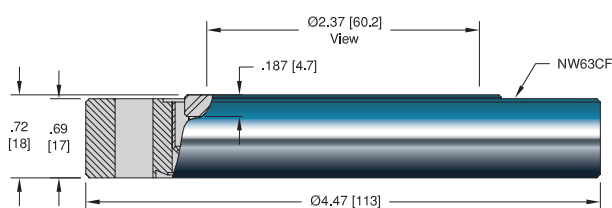



Weldable	VIEW DIAMETER	INSTALLATION	TEMPERATURE RANGE		MAGNETIC MATERIALS	PART NUMBER
			MIN	MAX		
	1.13 [28.7]	Weld	-65	200	No	11466-09-W*
	2.37 [60.2]	Weld	-65	200	No	11466-10-W*
	3.81 [96.8]	Weld	-65	200	No	11466-11-W*

ISO FLANGE

	1.13 [28.7]	NW50KF	-25	200	No	17109-01-KF*
---	-------------	--------	-----	-----	----	--------------

CONFLAT FLANGE

	1.13 [28.7]	2 3/4" (NW35CF)	-65	200	No	11466-01-CF*
	2.37 [60.2]	4 1/2" (NW63CF)	-65	200	No	11466-02-CF*
	3.81 [96.8]	6" (NW100CF)	-65	200	No	11466-03-CF*

Cryogenic Weldable	VIEW DIAMETER	INSTALLATION	TEMPERATURE RANGE		MAGNETIC MATERIALS	PART NUMBER
			MIN	MAX		
	1.37 [35]	Weld	-196	200	No	4901-01-W*
	1.37 [35]	Weld	-269	200	Yes	9600-01-W*

	1.37 [35]	2 3/4" (NW35CF)	-196	200	No	4900-01-CF*
	1.37 [35]	2 3/4" (NW35CF)	-269	200	Yes	4900-21-CF*

*This part is not RoHS compliant.

Specifications**Materials**

Housing: 304 Stainless steel
 Optic: UV Grade Fused Silica
 Magnetic Materials: See Table

Transmission Range (80% Min) 0.25 to 2 Microns

Temperature Range See Table

Pressure @ 20°C ISO KF 0 PSIG

1.13 View Dia.: 115 PSIG (7.9 Bar)
 1.37 View Dia.: 35 PSIG (2.4 Bar)
 2.37 View Dia.: 35 PSIG (2.4 Bar)
 3.81 View Dia.: 25 PSIG (1.7 Bar)



Description

Hermetic Extended Range Transmission Ports

As its name suggests, an extended range transmission port is an optical component that provides for transmission of radiation in either the ultra violet or infrared portion of the electromagnetic spectrum. Standard viewports made of either fused silica or sapphire have useful transmission from .25 microns to 2.5 or 5.0 microns respectively. Extended range window materials have a combined transmission range from .12 microns to 18 microns.

Of course no single window material can offer good transmission over the entire spectrum. Alkali halides such as calcium fluoride, CaF_2 , or magnesium fluoride, MgF_2 , offer excellent transmission in the deep ultraviolet. Polycrystalline CVD grown infrared transmitting materials such as Zinc Sulfide, ZnS, and Zinc Selenide, ZnSe, transmit radiation out to 14 and 18 microns respectively.

Many factors govern the selection of optical materials for the construction of a high and ultra high vacuum assembly. Whereas quartz and sapphire can be readily metalized and sealed to vacuum flanges by brazing, most optical materials are too weak to join to by the high temperature joining processes. Further, many optically transmitting materials are strongly hygroscopic (such as sodium chloride) or melt at low temperatures (such as glass). The physical and chemical properties of CeramTec's extended range transmission ports have been selected on the basis of optical transmission, vacuum compatibility, strength of materials and widespread usage by optical engineers.

Accordingly, the following materials are offered standard as extended range transmission ports:

Zinc Selenide – Best transmission available at 10.6 micron (CO_2 laser fundamental line) and in the visible. It has some absorption in the blue-green causing it to appear yellow. The index of refraction is high and thus requires anti-reflection coatings on both sides for optimum performance. This polycrystalline, CVD grown material is strong, though relatively soft compared to other crystalline, optical materials. It is non-hygroscopic. ZnSe sublimates at 300°C and reacts violently with strong mineral acids.

Cleartran™ Zinc Sulfide – Comparable to ZnSe in most respects, only slightly more absorbing at 10.6 microns. Advantage is the transmission in the visible is better, no absorption to only slight absorption in the blue-green thus appearing clear (i.e. not yellow). It is much harder than ZnSe and thus offers increased scratch resistance.

AR Coatings for both ZnSe and ZnS (Cleartran™) are standard and highly recommended for most applications. The exception is possibly for wide range pyrometry or spectrometry where artifacts from the coating materials leave a spectral "fingerprint" in regions beyond the useful transmission range of the coating. The standard coating has been specifically tailored to maximize transmission at 10.6 microns and will also transmit minimally 50% in the visible (i.e. remain at least partially transparent in the visible).

Calcium Fluoride – Best transmission by fluoride crystals in the UV (except very weak LiF). Relatively insoluble (non-to-very-low hygroscopic). Mechanically only slightly weaker than Zinc Selenide and slightly harder. Single crystal material with cubic symmetry, hence no birefringence. Calcium Fluoride is transparent in the visible (appears similar in color to quartz or glass) and in the UV down to 120nm, which services all excimer laser applications. Low index of refraction, which means that the windows rarely require anti-reflective coatings.

Magnesium Fluoride – Next best transmission of fluorides compared to CaF_2 and similar in all other characteristics with the following exceptions. MgF_2 is stronger and harder and is naturally, strongly birefringent.

View Diameter: .50 [13]

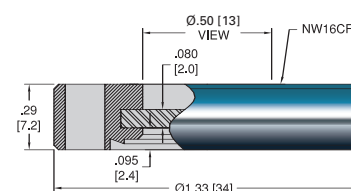

View Diameter: 1.10 [28]

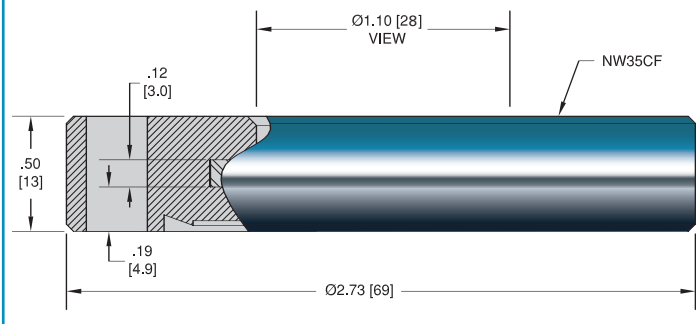

Specifications

Materials

Flange: 304 Stainless steel
O-ring: Viton®
Optics: See Table
Magnetic Materials: Yes

Transmission Range 0.12 to 20 Microns (See table)

Temperature Range -8°C to 204°C



MATERIAL	INSTALLATION	ANTI-REFLECTIVE COATINGS	TRANSMISSION RANGE	%MIN	PART NUMBER
Zinc Selenide	1 1/3" (NW16CF)	10.6 Micron	10.6 Micron optimized	98	19485-01-CF
Cleartran™	1 1/3" (NW16CF)	10.6 Micron	10.6 Micron optimized	98	19485-02-CF
Magnesium Fluoride	1 1/3" (NW16CF)	No	0.12 to 7 Microns	-	19485-03-CF
Calcium Fluoride	1 1/3" (NW16CF)	No	0.12 to 9 Microns	-	19485-04-CF
Zinc Selenide	1 1/3" (NW16CF)	No	0.55 to 18 Microns	-	19485-05-CF



Zinc Selenide	2 3/4" (NW35CF)	10.6 Micron	10.6 Micron optimized	98	19163-01-CF
Cleartran™	2 3/4" (NW35CF)	10.6 Micron	10.6 Micron optimized	98	19163-02-CF
Magnesium Fluoride	2 3/4" (NW35CF)	No	0.12 to 7 Microns	-	19163-03-CF
Calcium Fluoride	2 3/4" (NW35CF)	No	0.12 to 9 Microns	-	19163-04-CF
Zinc Selenide	2 3/4" (NW35CF)	No	0.55 to 18 Microns	-	19163-05-CF

Extended Range Transmission Curves

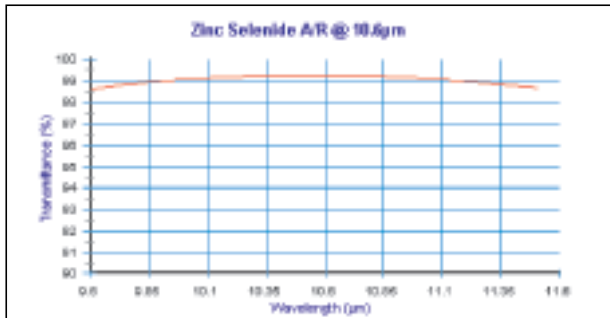
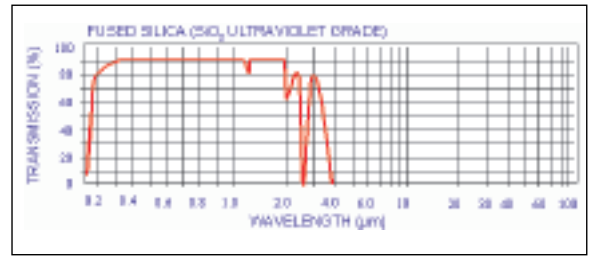
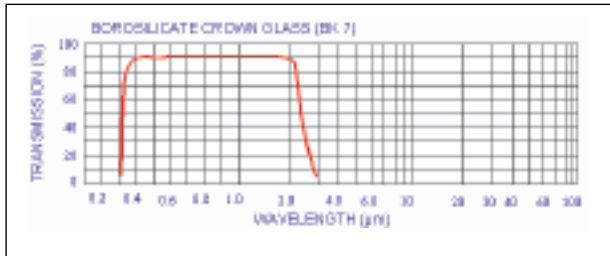
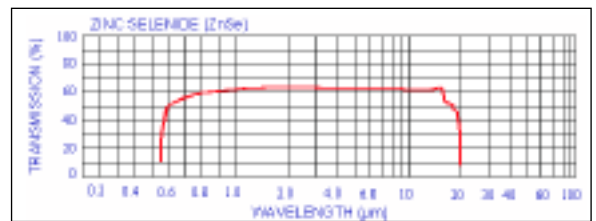
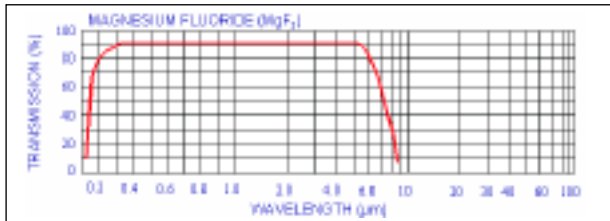
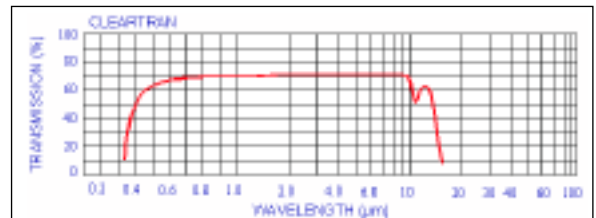
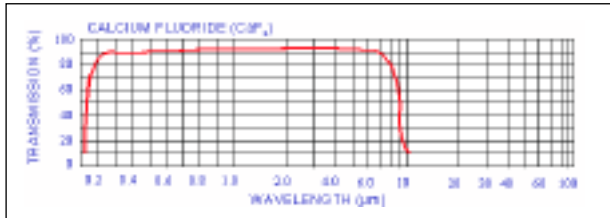

Transmission charts are for reference only. These transmission curves are based on a 10mm window thickness. Thermal gradient should not exceed 10°C/minute.

VIEWPORT



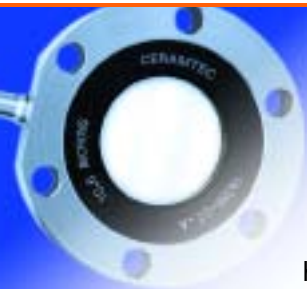

Description

Differentially Pumped, Extended Range, Viewports for Extreme High Vacuum (EHV) Applications

EHV applications demand exceedingly high seal reliability. These requirements for vacuum integrity lead to consideration of two limits to commercial leak detection. First, what is the typical helium sensitivity for commercially available leak detectors; and second, what are the practical limitations of helium mass spectrometer (MS) leak rate certification.

While helium MS leak detection systems are sensitive to leak rates less than 10^{-11} STD cc/sec, commercial vacuum seals are certified only for leak rates of less than 10^{-10} STD cc/sec. In these instances, the discrepancy between that achievable versus the reported sensitivity is not due to the presence of small, measurable leaks ($<10^{-11}$ STD cc/sec). Rather, the reduced certification is due to the difficulty of performing a reliable leak test with de-mountable hardware. An all metal welded joint to an MS leak detector, for example, could readily and reliably be certified to leak rates less than 10^{-11} . This type of joint is not practical for most de-mountable vacuum components. Even in the case of a copper gasket seal, the process of sealing is not only too time consuming but also would cosmetically alter the finished part.

In other instances, such as in inert gas chronology measurements, where the desired background levels due to atmospheric argon or helium are actually below the level of instrument sensitivity; it is not possible to measure with sensitivity at the desired leak rate with commercially available Helium MS leak detectors.

In both instances, a differentially pumped vacuum seal can ensure EHV reliability. Arranging two or more seals such that the space between the seals is accessible to an appended vacuum pump creates a differentially pumped seal. Typically, each seal is readily qualified to have leak rates $<10^{-10}$ STD cc/sec. By actively pumping the region between the seals, minute leakage through the atmospheric seal is further rarified to ensure that leakage through the inner seal is reduced by several orders of magnitude. Thus, differential pumping ensures EHV reliability.

CeramTec's differentially pumped, extended range, viewports have been designed specifically for such extreme high vacuum (EHV) applications including inert gas chronology.

Extreme / Custom Design

- Larger viewport view diameters to fit within a 4 1/2" ConFlat flange.

- Different optics are available upon request. For example, Silicon, Germanium, Zinc Sulfide
- Specialized coatings are also available.
- Custom pumping port termination options are available.

Installation

All of CeramTec's standard differentially pumped viewports are mounted within a 2 3/4" or 4 1/2" ConFlat flange. For information on ConFlat flange installation, refer to the Technical Reference section.

Applications

A few of the many applications in which these differentially pumped viewports are commonly used are:

- Geochronology
- Geology
- Argon Dating

View Diameter: 1.10 [28]

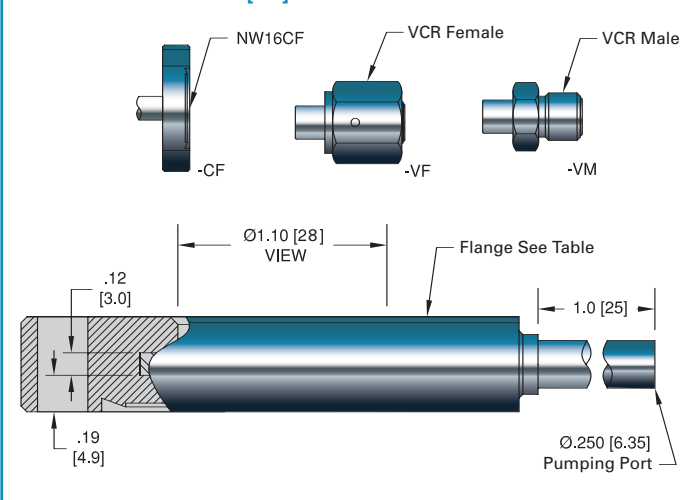

Specifications

Materials

Flange: 304 Stainless steel
 O-ring: Viton®
 Optics: Zinc Selenide or Cleartran
 Magnetic Materials: Yes

Transmission Range 10.6 Micron optimized

Anti-reflective Coating Yes

Temperature Range -8°C to 204°C

1.10 View Dia.
ConFlat

MATERIAL	INSTALLATION	TRANSMISSION RANGE	%MIN	TERMINATION OPTIONS	PART NUMBER
Zinc Selenide	2 3/4" (NW35CF)	10.6 Micron optimized	98	Tube	19286-01-A
Zinc Selenide	2 3/4" (NW35CF)	10.6 Micron optimized	98	1 1/3" ConFlat	19286-01-CF
Zinc Selenide	2 3/4" (NW35CF)	10.6 Micron optimized	98	Male VCR	19286-01-VM
Zinc Selenide	2 3/4" (NW35CF)	10.6 Micron optimized	98	Female VCR	19286-01-VF
Cleartran™	2 3/4" (NW35CF)	10.6 Micron optimized	98	Tube	19286-02-A
Cleartran™	2 3/4" (NW35CF)	10.6 Micron optimized	98	1 1/3" ConFlat	19286-02-CF
Cleartran™	2 3/4" (NW35CF)	10.6 Micron optimized	98	Male VCR	19286-02-VM
Cleartran™	2 3/4" (NW35CF)	10.6 Micron optimized	98	Female VCR	19286-02-VF
Zinc Selenide	4 1/2" (NW63CF)	10.6 Micron optimized	98	Tube	19781-01-A
Zinc Selenide	4 1/2" (NW63CF)	10.6 Micron optimized	98	1 1/3" ConFlat	19781-01-CF
Zinc Selenide	4 1/2" (NW63CF)	10.6 Micron optimized	98	Male VCR	19781-01-VM
Zinc Selenide	4 1/2" (NW63CF)	10.6 Micron optimized	98	Female VCR	19781-01-VF
Cleartran™	4 1/2" (NW63CF)	10.6 Micron optimized	98	Tube	19781-02-A
Cleartran™	4 1/2" (NW63CF)	10.6 Micron optimized	98	1 1/3" ConFlat	19781-02-CF
Cleartran™	4 1/2" (NW63CF)	10.6 Micron optimized	98	Male VCR	19781-02-VM
Cleartran™	4 1/2" (NW63CF)	10.6 Micron optimized	98	Female VCR	19781-02-VF

